

Welcome to Luoyuan Photovoltaic TPT/EVA Automatic Cutting and Punching Machine

This equipment has obtained the national invention patent, patent
number: ZL2010 1 0173312.4

We will be happy to help you !

TPT/EVA automatic cutting and punching machine

Technical Manual

Qidong Luoyuan Photovoltaic Equipment Co., Ltd.

Address: No. 8, Huihe West Road, Huifeng Town, Qidong City, Jiangsu Province

Company Profile:

Luoyuan Photovoltaic Equipment Co., Ltd. is a private high-tech enterprise, which was awarded the title of Private Technology Enterprise of Jiangsu Province and passed the ISO9001:2008 quality management system certification. With the “Luoyuan” brand as its strategic orientation, the company continues to innovate and improve the manufacturing process of solar photovoltaic equipment with its unique understanding of solar photovoltaic equipment manufacturing and excellent research and development capabilities. The market for TPT/EVA automatic cutting equipment has solved the gap of domestic professional machines.

Use and maintenance instructions

- ◆ Thank you very much for purchasing the products of Luoyuan Photovoltaic Equipment Co., Ltd.
- ◆ Please read the “Operation and Maintenance Instructions” carefully before use to ensure proper use. After reading the instructions, please keep them in a safe place for future reference.
- ◆ When using our TPT/EVA fully automatic cutting and punching machine, be sure to follow the safety precautions described in the instructions.
- ◆ Friendly reminder: Do not reprint the entire contents of this manual without authorization.
- ◆ In the preparation of this manual, although it strives to be perfect, it is inevitable that there are doubts, errors and omissions. I hope that you can improve your opinions and thank you for your support.

Foreword:

Thank you for choosing LY-DM-TPT/EVA automatic cutting and punching machine, please accept our sincere gratitude!

The fully automatic cutting and punching machine is a special equipment for the photovoltaic industry designed, developed and manufactured by Luoyuan Photovoltaic. The equipment is based on the improvement of the original semi-automatic cutting machine. The device is a fully intelligent solar module manufacturing industry with functions of automatic feeding, automatic discharging, automatic deviation correction, automatic fixed length, automatic punching, automatic cutting, automatic receiving and stacking, automatic counting, static elimination and the like. Professional setting. The market of the equipment solves the blank of no special equipment in China, and also makes up for the problem that the cutting precision of foreign equipment is not high, the price is expensive, and it is not compatible with the production of domestic components.

The equipment control system has changed the traditional button control, and adopts the man-machine interface PLC control system. The layout of the whole machine is reasonable, the operation is simple, the maintenance is convenient, and the EVA/TPT is universal. The equipment realizes the fully automated production mode, improves the cutting efficiency, enhances the corporate image, and further improves the economic benefits of the enterprise.

Table of Contents

Chapter One、 Use and installation.....	5
1-1 Appearance.....	6
1-2 Safety and warning	6
1-3 Installation and transportation	7
Chapter Two、 Parameter function description	8
2-1 Structural principle.....	8
2-2 Main feature	8
2-3 The main parameters.....	9
Chapter Three、 Equipment operation	15
3-1 Operation method.....	15
3-2 Operational precautions	16
3-3 Parameter setting description.....	19
Chapter Four、 Abnormal situation and treatment	31
Chapter Five、 Protection and inspection.....	34
5-1 Regular maintenance inspection	34
Chapter Six、 After sales service.....	35

Chapter One、 Use and installation

1-1 Appearance

1-2 Safety and warning

1-3 Installation and transportation

After the customer receives the product, if the machine is temporarily not used, for the safety of future maintenance and in compliance with the warranty of the company, the following points must be paid attention to during storage.



注意 Caution

- Must be placed in a ventilated, dust-free, dry location
- The ambient temperature at the storage location must be in the range of 0 °C to +50 °C.
- The relative humidity of the storage location must be in the range of 0% to 80% with no condensation.
- Avoid storage in environments containing corrosive gases and liquids.
- If the surrounding environment is bad, the desiccant should be placed in the box.
- Avoid installation in direct sunlight or vibration.
- Even if the humidity meets the specifications, such as sudden changes in temperature, condensation and icing may occur, and storage should be avoided.
- Do not leave it for more than one year without power.

1-1 Appearance

Each TPT/EVA fully automatic cutting and punching machine undergoes strict quality control before being shipped from the factory, and is made of enhanced anti-collision packaging. After the customer receives the device, please perform the following check steps immediately.

Check if the TPT/EVA fully automatic cutting and punching machine is damaged during transportation.

Check if the TPT/EVA automatic cutting and punching machine is complete.

※If the accessories are found to be inconsistent with the accessories listed in this manual, please contact us.

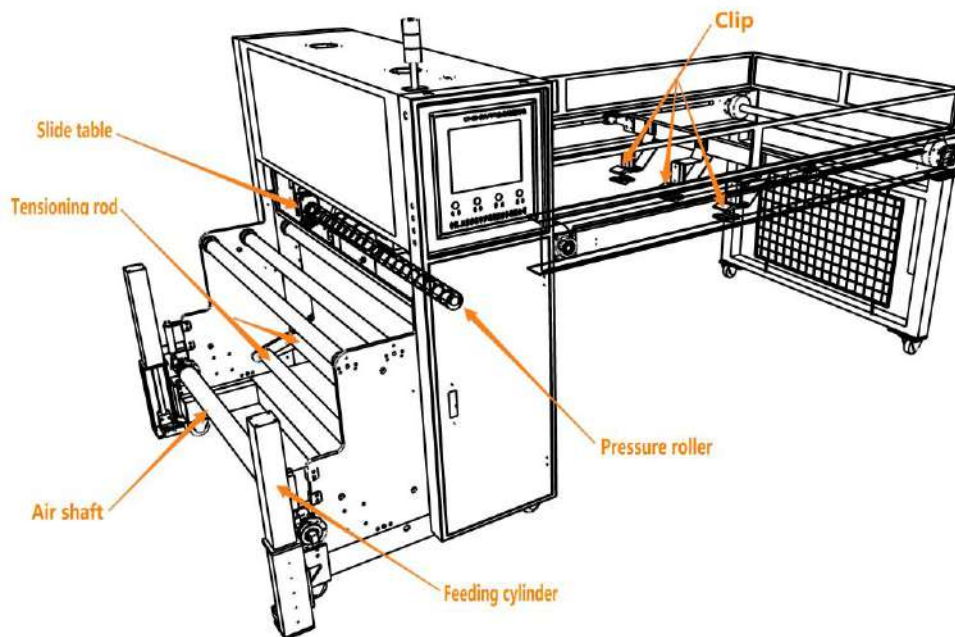

1-2 Safety and warning

1-2-1 General rule

- ⚠ Improper use of the device may result in personal injury!
- ⚠ Do not stand or climb above the device.
- ⚠ Forcibly reaching into the transport mechanism or equipment, and removing the safety cover may pose a risk of personal injury.
- ⚠ Please follow the instructions in this manual when transporting the machine.
- ⚠ Any modification or change of the equipment must be approved by Luoyuan Photovoltaic Equipment Co., Ltd.
- ⚠ Only use the recommended parts.
- ⚠ Only authorized personnel can disassemble the electrical enclosure. Luoyuan Photovoltaic Equipment Co., Ltd. is not responsible for any accidents, personal injury or equipment damage caused by failure to follow the instructions in this manual.

Maintenance technician should:

- Ability to read technical related information
- Can read technical illustrations
- Basic mechanical and electrical knowledge
- Basic mathematics
- Ability to use tools correctly

Electrical mechanic:

- Have similar types of installation experience.
- It has the technology to see the picture and the operation according to the wiring.
- Knowledge of local electrical and automation safety rules.
- Only technicians with relevant technical knowledge or sufficient experience can avoid the dangers caused by electric power. Only such technicians can repair the electrical components of the equipment.

Machine operator:

-- The machine operator must undergo technical training from Luoyuan to operate the equipment.

1-2-2 emergency stop

 In the event of a hazard to personnel or damage to the equipment, the emergency stop button should be pressed immediately or the power to the box should be turned off.

 The emergency stop button is located on the main control box.

Note: An emergency stop does not cut off the power supply to the machine.

1-2-3 Safety shield

 This device contains parts that can move and can cause injury! These removable parts have a fixed safety shield that should not be manipulated if any of the safety shields are not properly installed.

 These guardrails should be securely fastened when the equipment is in operation. This fixed protection must not be removed unless the power and air supply are in a power-off lock/marked safe state.

1-3 Installation and transportation

According to the standards of Luoyuan Photovoltaic Equipment Co., Ltd, it is installed and fixed to ensure the normal operation of the equipment. If the equipment needs to be moved to another location, the ground wire and the reinforcement foot screws must be reconnected. Only trained personnel can remove and reconnect the wires.

Chapter Two、 Parameter function description

2-1 Structural principle

2-2 Main feature

2-3 The main parameters

2-1 Structural principle

The automatic cutting machine is a special equipment for the production of solar modules capable of cutting TPT/EVA materials. The machine adopts steel structure and electromechanical integration, automatic feeding and discharging; using material level sensor control, servo motor fixed length, cutting The material adopts superconducting rodless cylinder system, the discharge static electricity is eliminated, and the material can be placed on the receiving platform automatically; the control is composed of PLC+microcomputer touch screen control principle.

2-2 Main feature

1. This cutting machine can cut two different materials of TPT/EVA. Completely solve the problem that the two materials cannot be cut on the same equipment. Save the company's repetitive investment in fixed equipment.
2. Easy to operate, using PLC and man-machine interface, easy to operate.
3. This machine has strong adaptability, the length range is 0~2000mm, the width is ≤ 1100 mm, and the dimensional accuracy is high.
4. Simple feeding, single operation, no need to lift materials, saving labor.
5. The punching position can be adjusted freely, the cutting edge and the material can be adjusted horizontally and vertically, and the punching slit width can be adjusted.
6. Adopt servo motor control, cutting speed is fast, and it has infrared

positioning system with high precision.

7. Unique automatic discharging system, easy to operate and fast.
8. After the cutting, the material will be automatically collected, and the materials will be automatically stacked on the receiving turnover car to save the production cost of the chip after cutting.
9. The new design adopts rodless cylinder and hobbing technology, cutting fast, smooth and smooth burr.
10. Fully consider the static electricity generated during production, uniquely equipped with static dehumidification device to reduce the trouble of static electricity generation.
11. Have safety guards to prevent workers from accidents.
12. Automatic counting, with an abnormal alarm system to improve work efficiency.
13. The device is equipped with an operation password and an administrative password, and the device owner can adjust the parameters arbitrarily.

2-3 The main parameters:

1、Equipment use

It is used for cutting and boring the backsheet TPT and EVA coils required for PV module production.

2、Equipment process parameters

2.1 Cutting size: 500mm---2000mm。

2.2 Reel specifications: inner diameter 76mm outer diameter \leq 600mm, maximum load capacity 200 kg.

2.3 Cutting accuracy: dimensional error: TPT \pm 2mm, EVA \pm 2mm.

Diagonal size error: \leq 3mm.

2.4 Punching size: 0---125mm。

2.5 Punching position: deviation \pm 1mm.

2.6 Cutting width: effective width \leq 1100mm.

2.7 Cutting effect: cutting, punching, no burr, no scratches, indentations, wrinkles, etc.

2.8 Cutting compatible: It can realize the cutting and opening of TPT/EVA materials. The opening method is carried out by using a die.

2.9 Opening tool: Different opening tools are standardized in size and quick to change.

2.10 Crop count: The cropping process is automatically counted and displayed on the display.

3、Equipment technical parameters

3.1 Production beat: 8-10 sheets/min.

Single person feeding and convenient feeding, single person can launch the receiving car.

3.2 Feeding mechanism: the air-up shaft is used for feeding, the cylinder lifting mechanism is used to raise the material shaft, and the material shaft enters the discharging mechanism.

Infrared proofing for easy alignment of the baseline when loading.

3.3 Discharge mechanism: The mechanism smoothly delivers the material, and the material level sensor controls the discharge with constant tension.

3.4 Feeding mechanism: pneumatic clamp receiving material, with automatic material-free identification function; automatic shutdown when there is no material.

3.5 Conveying mechanism: no scratches or wrinkles on the material during transmission.

3.6 Punching mechanism: The cylinder is used to control the punching, and the opening position can be set in the program.

3.7 Cutting mechanism: It is cut with a hob, and the slit is smooth without abnormal appearance and non-adhesive material.

3.8 Receiving device: The pneumatic clamp automatically places the cut material on the receiving platform.

3.9 Program control: PLC control, touch man-machine interface; program has the function of saving cropping recipe.

3.10 Electrostatic treatment: The device has the function of eliminating static electricity to the greatest extent;

3.11 Receipt platform: adopts flat-type receiving, automatic blanking to the receiving platform.

3.12 Safety protection:

1) The loading area is protected by safety door interlocking.

2) Equipped with an emergency stop button. Press the emergency stop and the device will stop running immediately.

3) Light curtain protection system is arranged in the cutting and receiving area.

4) PLC program is equipped with foolproof function, standard operation, reducing the risk of misoperation.

3.13 Password protection: The device password is divided into the device operation password and the administrator password.

3.14 Operation screen: It adopts touch human-machine interface, which

is intuitive to set up and easy to operate.

3.15 Alarm system: Three color warning lights are installed on the device.

When the device is in normal condition, the green light is on, the yellow light is on when the device is in standby, and the red light is on when the device is faulty and a buzzer sounds.

3.16 Fault Query: When a fault occurs, an alarm message will appear on the display unit to facilitate maintenance by the equipment personnel.

The alarm information includes: fault type and fault location, and the alarm record is automatically saved.

For safety, after the alarm is eliminated, it needs to be manually reset before automatic operation can be performed.

3.17 Applicable air pressure: 0.6~0.8MPa. The air supply interface is 10mm.

3.18 Equipment power: 2.25kw

3.19 Equipment power supply: AC 220V, must be reliably grounded.

3.20 Equipment size: 3500mm*1700mm*1700mm

3.21 Equipment weight: 1800KG

TPT/EVA automatic cutting and punching machine

Main component brand

Control System

item	Product name	Brand	Place of origin	model	Remarks
1	touch screen	Vylon	TaiWan	TK6100	HMI
2	PLC	Omron	Japan	CP1H-X40DT-D	PLC
3	server driver	Mitsubishi	Japan	MR-JE-70A	Servo 1 and Servo 2
4	servo motor	Mitsubishi	Japan	HG-KN73J-S100	Servo 1 and Servo 2
5	Planetary reducer	Pin macro	TaiWan	DH090-L1-5	Matching with the servo
6	Three-phase asynchronous motor	Xinling	China	Y2-80M2-4 0.75KW	Discharge motor
7	Gearbox		China	NMRV063 80B5 i=5	Discharge motor matching
8	Photoelectric switch	panasonic	Japan	CX442	Paper induction photoelectric switch
9	Photoelectric switch	Omron	Japan	EE-SX471 EE-SX671A	Clip limit position sensing
10	Proximity switch	Befining	China	GBM8-18GM	Constant tension roller position sensing
11	AC contactor	Schneider	China	LCE11210M5N	
12	Intermediate relay	Omron	China	NY2NJ	
13	Frequency converter	Delta	China	VFD007M21A	Control discharge motor
14	Angle encoder	Huituo	China	RE-38-02	Constant tension roller induction
15	Negative ion generator	Ansoll	China	AS 6201A	Weaken static electricity
16	cylinder	SMC/Yadeke	Japan /TaiWan		
17	The electromagnetic valve	SMC/Yadeke	Japan /TaiWan		

Chapter Three、 Equipment operation

3-1 Operation method

After the device is powered on, the screen of the touch screen is displayed as shown below. Press the “Language” in the lower corner of the boot screen.

The enter button for the next step.



Enter the main interface as shown below,

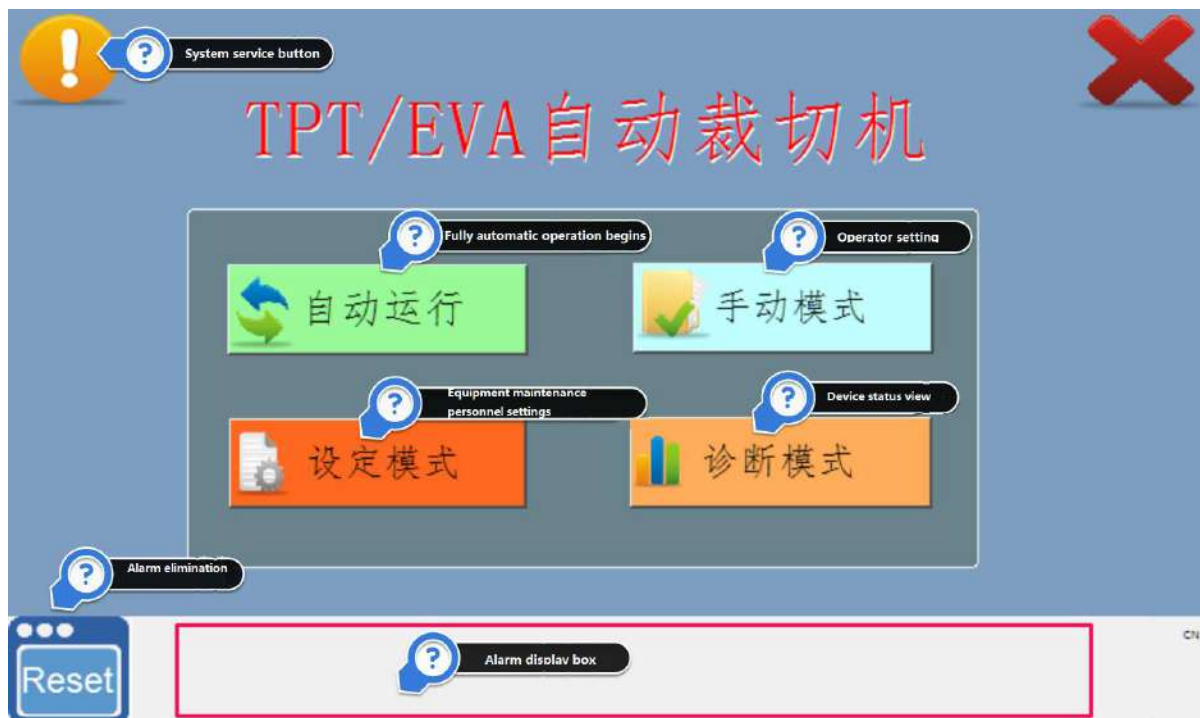

Press the “System Reset” button and the device will perform a system reset. This button will be displayed in red after reset. As shown below:



The main screen is divided into 4 sub-operation buttons, which are:

- 1: Automatic running;
- 2: Manual mode
- 3: Setting mode;
- 4: Diagnostic mode.

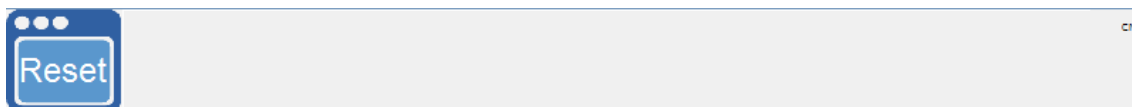

The bottom is the alarm information display part.



Alarm elimination button.

Different interfaces can be accessed by selecting different buttons to complete different operational requirements.

In order to protect the corresponding content of the settings, you need to have certain permissions to implement the related operations. Therefore, you need to enter a password before entering this operation. Only when the password is correct can you enter this function.

① Automatic running

Click the "Auto Run" button to enter the auto run screen
 if you do not perform a system reset, you will enter the automatic operation interface directly. The screen will prompt you to reset the system. As shown below:



The normal screen is displayed as follows:



In the running interface, first set the number of sheets to be completed, and then click Start to automatically complete the cropping function. The device will automatically complete according to the set length and number of sheets. It will automatically stop running after completion.

In this operation interface, the "start" and "stop" of the device are operated by the buttons displayed on the touch screen.

The operating status of the device and related parameters are also displayed on the touch screen for operational reference.

Before starting automatic operation

Please confirm the current running material, punching method, cutting length, etc.



② Setting screen:

1: In the right half of the screen, there are six sub-picture selection items, namely "Servo 1", "Servo 2", "Parameter 1", "Parameter 2", "Program", and "Password Modification". Their functions are:

1) 、Set the length to be cut. There are 3 sub-settings in the length setting, which are "cut total length", "punching length", and "send to the paper length". After the setting of these three parameters is completed, the length of the paper to be cut is set. Click the "Run" button to simulate the device, or you can complete the single cropping function. It is recommended that this function be used to check whether the actual length of the paper matches the set length before normal automatic operation.

2) 、The two position settings of the motor, that is, the "paper position setting" and "paper position setting" position can be the same position as the cutting position.

3) 、Parameter 1 is used to set the speed at which the motor runs.

4) 、Parameter 2 sets the pulse number and material selection, and the cutting mode is selected.

Servo 1 setting screen as shown below.

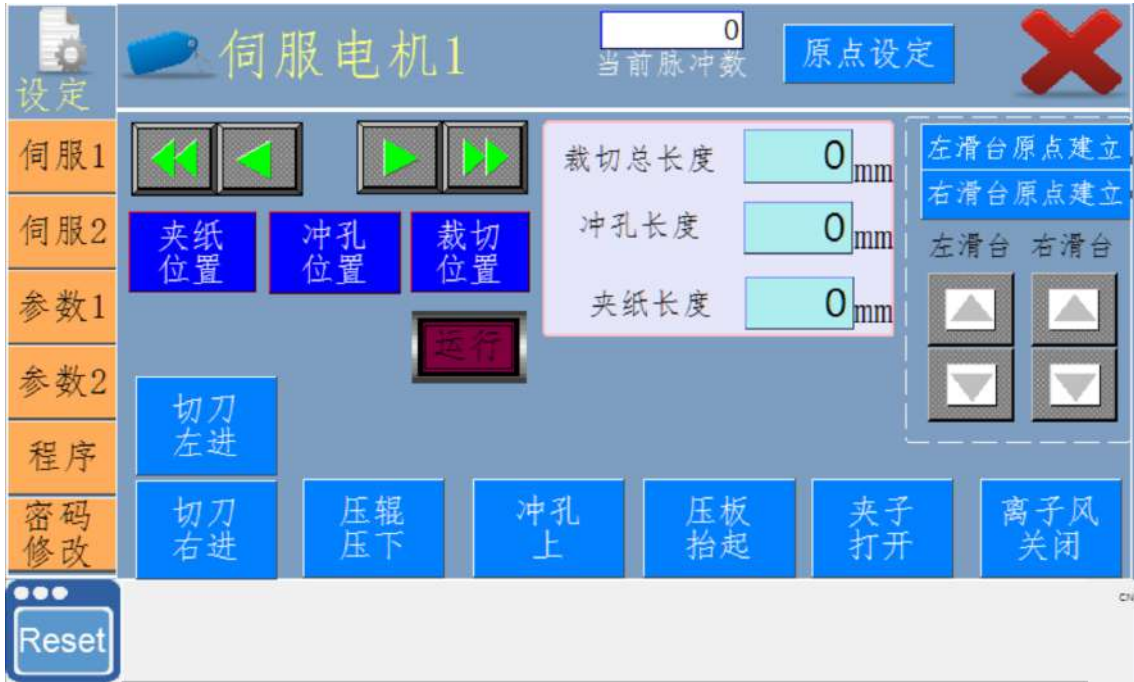

Servo 2 setting screen:

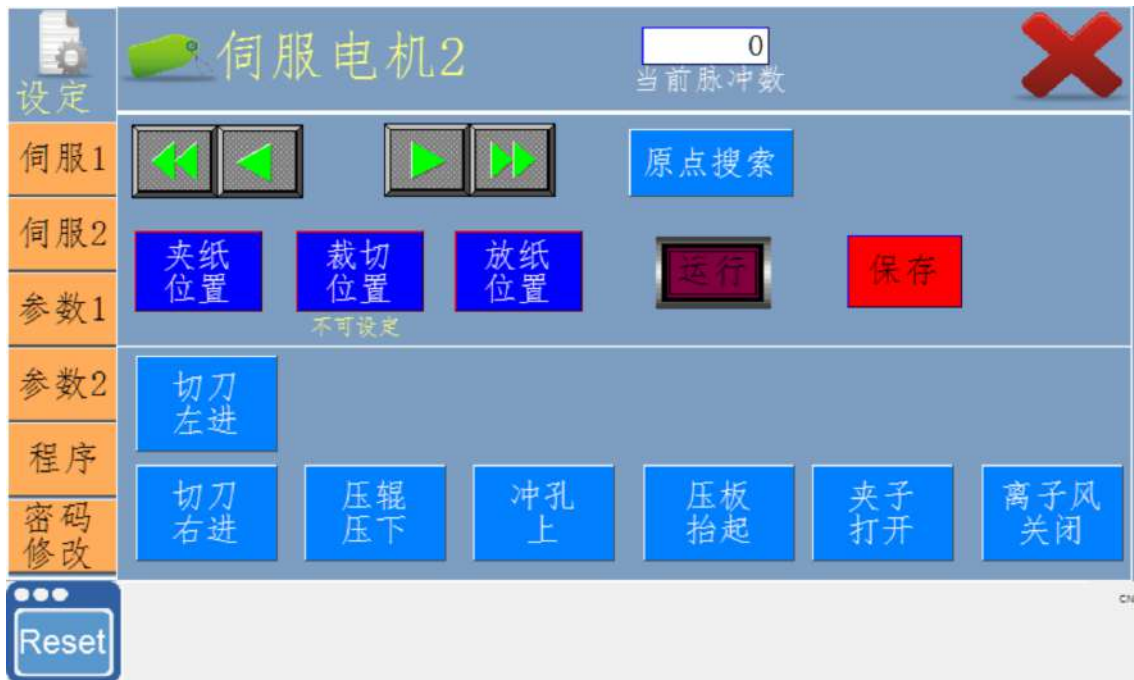

Parameter 1 setting screen:

Category	Servo 1	Servo 2
点动高速	200 mm/s	200 mm/s
到夹纸位速度	1000 mm/s	1500 mm/s
点动低速	50 mm/s	50 mm/s
到夹纸位速度	1000 mm/s	1000 mm/s
到放纸位速度	-	1000 mm/s
到裁切位速度	1000 mm/s	-
滑台点动速度	-	2 mm/s

Parameter 2 setting screen:

Category	Value / Option	Unit / Description
定长脉冲数	0	
TPT校正脉冲数	50.00000	
EVA校正脉冲数	51.66600	
TPT压辊深度	12.00	mm
EVA压辊深度	11.88	mm
冲孔中工作	[Button]	
冲孔边工作	[Button]	
冲孔选择	[Button]	
夹子打开延时	0	X0.1S
夹子返回延时	0	X0.1S
冲孔延时	0	X0.1S
TPT	[Button]	材料选择
不循环裁切	[Button]	切刀方式选择
纸感应有效	[Button]	纸感应开关
3000	[Input]	放纸位选择

5) 、 Program save function

According to the different process requirements of the customer, the relevant setting parameters are saved under different files. It is not necessary to set various parameters from the beginning when re-production, and only need to select the products previously made under the program opening interface, the relevant parameters. Will be called. "Save" and "Open" are the opposite process. In the operation, the current process parameters are saved and the file name is created. Can be called later after saving.

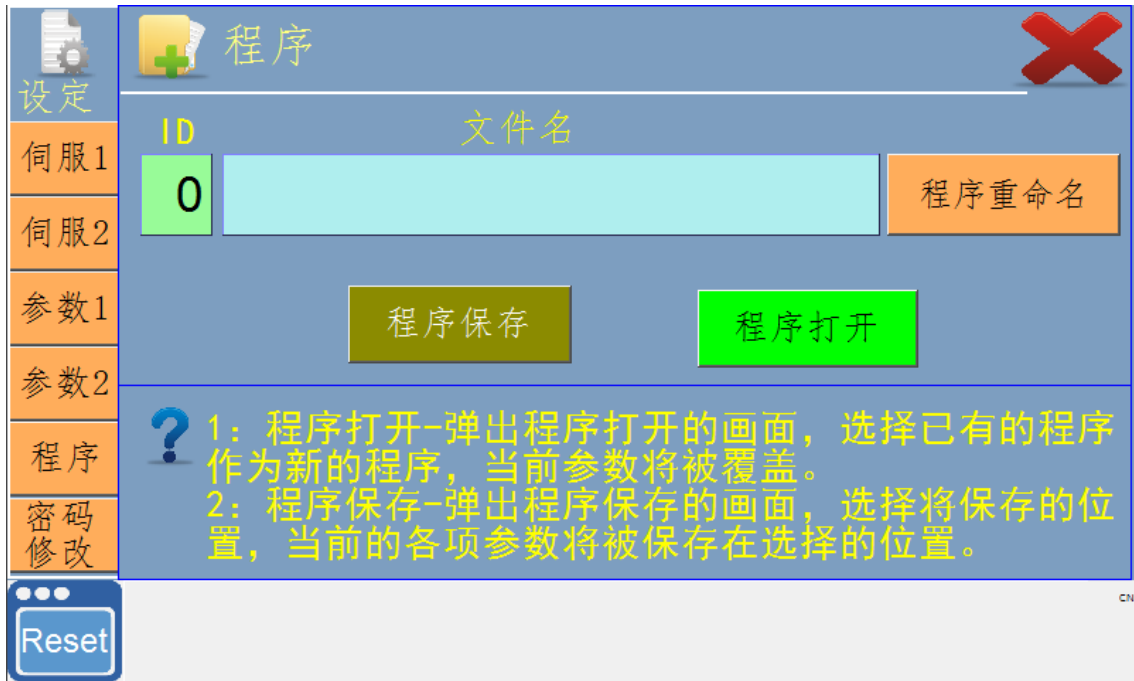

6) 、 Change Password



Change the current password to enter the setting screen.

Method:

Enter the password you want to modify in the direct number box, then click OK.

The manual interface is similar to the setting parameter interface, except that the cutting length and other parameters cannot be set.

Manual servo 1 setting screen:

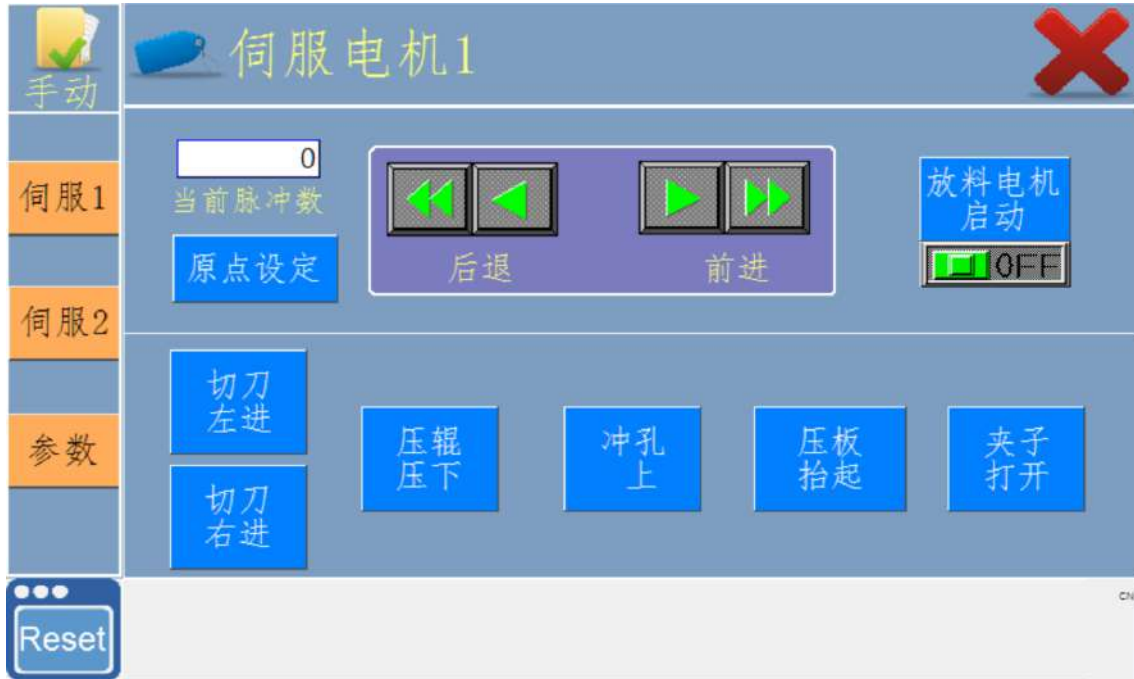

Manual servo 2 setting screen:

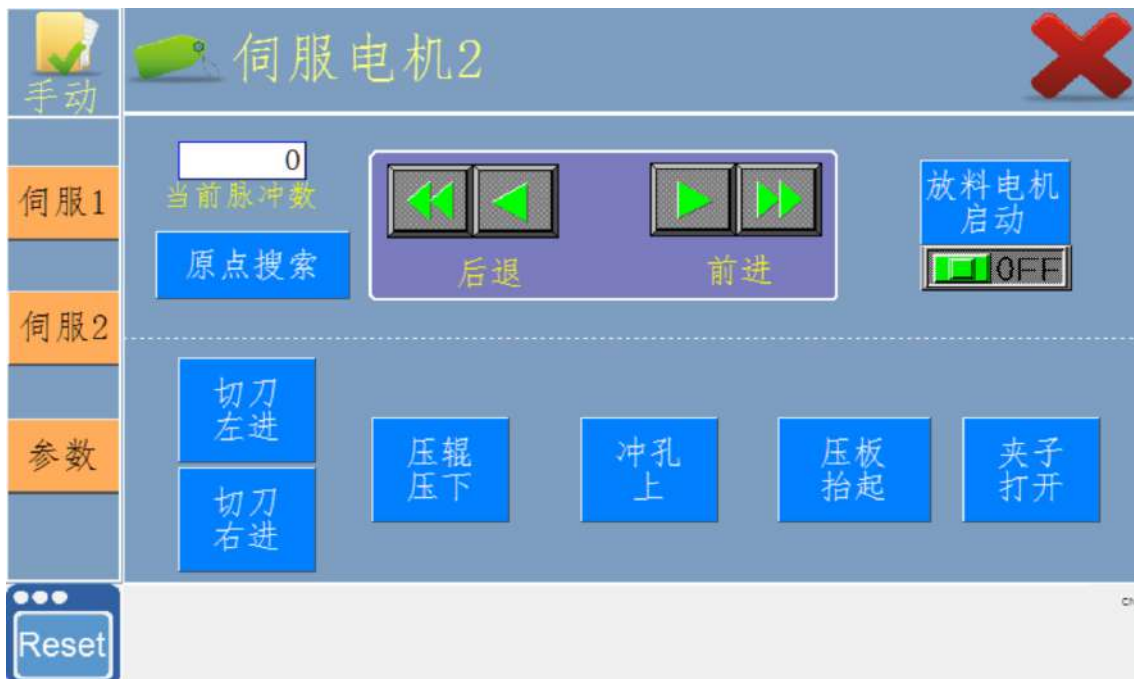

Some solenoid valves can be operated with simple manual operation and can check whether the relevant solenoid valve is working properly during operation.

Diagnostic screen for diagnostic and maintenance use of the device.

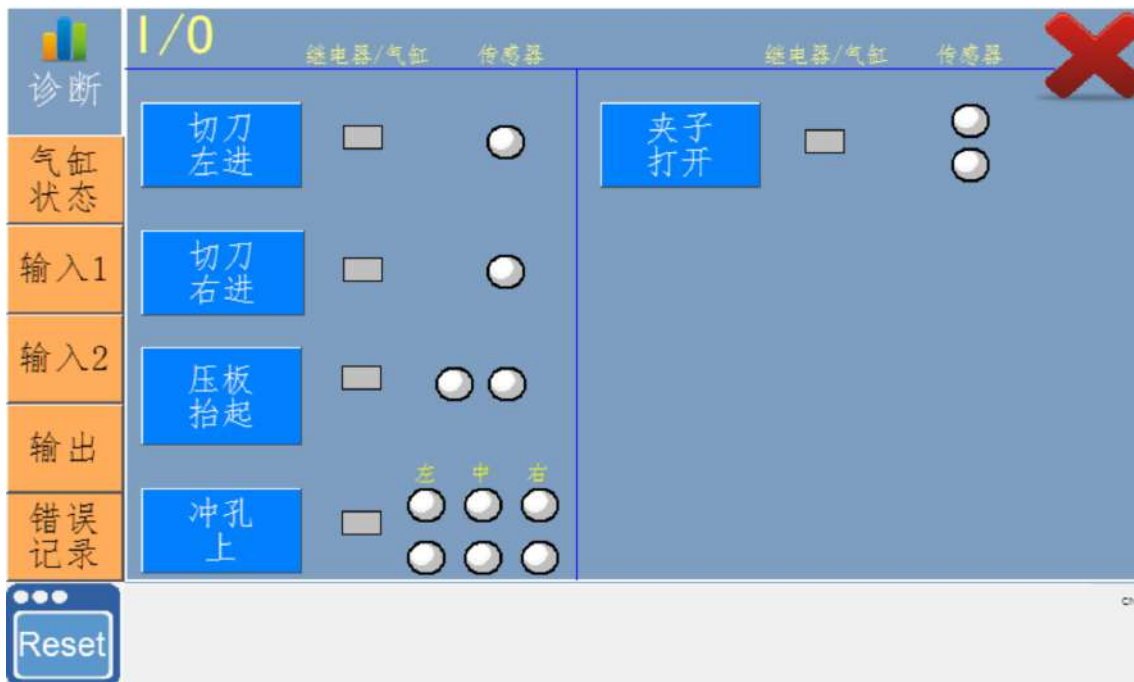

Diagnostic input 1 screen:



Diagnostic input 2 screen:

Category	Item ID	Description
诊断	2.00	右冲孔上感应*
诊断	2.01	伺服2准备完成
气缸状态	2.02	伺服2报警
气缸状态	2.03	冲孔上感应
输入1	2.04	冲孔下感应
输入1	2.05	安全门感应
输入2	2.06	张紧辊上极限
输入2	2.07	张紧辊未放下
输出	2.08	安全光栅
输出	2.09	右冲孔下感应*
错误记录	2.10	右冲孔下感应*
错误记录	2.11	空

Diagnostic output screen:

Category	Item ID	Description
诊断	100.00	伺服电机2 CW
诊断	100.01	伺服电机1 CCW
气缸状态	100.02	伺服电机2 CW
气缸状态	100.03	伺服电机2 CW
输入1	100.04	左滑台CW
输入1	100.05	左滑台CCW
输入2	100.06	右滑台CW
输入2	100.07	右滑台CCW
输出	102.00	灯(黄)
输出	102.01	灯(绿)
错误记录	102.02	Servo1 On
错误记录	102.03	Servo1 Alm Rst
输出	101.00	中间冲孔电磁阀
输出	101.01	放料电机开关
输出	101.02	压板电磁阀
输出	101.03	夹子电磁阀
输出	101.04	离子风电磁阀
输出	101.05	两侧冲孔电磁阀*
输出	101.06	右切刀电磁阀
输出	101.07	灯(红)
输出	102.04	Servo2 On
输出	102.05	Servo2 Alarm Reset
输出	102.06	Buzzer
输出	102.07	左切刀电磁阀

HistoryRecord

Time	Description
07:56:17	裁切数量未设定
07:56:17	裁切数量未设定
13:15:37	裁切数量未设定
13:15:37	裁切数量未设定
13:18:29	裁切数量未设定
13:18:29	裁切数量未设定
13:19:10	裁切数量未设定
13:19:10	裁切数量未设定
14:51:29	裁切数量未设定
14:51:29	裁切数量未设定
15:27:17	裁切数量未设定
15:27:17	裁切数量未设定
15:27:45	裁切数量未设定

③Parameter Settings

一、Pulse calculation method

Purpose: Correct the difference between the length setting value and the actual cutting length value.

Click "Setting Mode" to enter the "Parameter 2" setting, as shown below

参数设定

X= 50.00000

a= 0 定长脉冲数

TPT校正脉冲数: 50.00000

EVA校正脉冲数: 51.66600

参数1: TPT压辊深度 12.00 mm

参数2: EVA压辊深度 11.88 mm

冲孔中工作: 0 X0.1S

冲孔边工作: 0 X0.1S

冲孔选择: 0 X0.1S

冲孔延时: 0 X0.1S

夹子打开延时: 0 X0.1S

夹子返回延时: 0 X0.1S

程序: TPT (材料选择), 不循环裁切 (切刀方式选择), 纸感应有效 (纸感应开关), 3000 (自定义), 自定义 (放纸位选择)

1. a= fixed length pulse number

The number of pulses that servo motor 1 runs under the current length setting. This parameter is read only;

2. X = number of correction pulses

The number of pulses per 1mm servo motor 1 operation, that is, the correction value; the number of TPT correction pulses and the number of EVA correction pulses, respectively, the number of TPT correction pulses corresponds to the length factor in the TPT operation mode, and the number of EVA correction pulses corresponds to the length in the EVA operation mode. Factors, please do not confuse; This parameter is important data for length measurement, ⚠ Non-professionals should not modify;

3. L = actual measured value of current material

This parameter is a manual tape measure; for the purpose of accurate calibration, the L value should be taken as the average of 3-5 current material measurements; please confirm the type of current measurement material, do not confuse;

Calculation formula:

$$X = \frac{a}{L} = \frac{\text{Number of fixed length pulses read}}{\text{Actual measured value of current material } mm}$$

If the current measurement material is TPT, substitute the X value into the TPT correction pulse number parameter;

If the current measurement material is EVA, the X value is substituted into the EVA correction pulse number parameter;

The calculated X value should be in the range of 50-105. If there is any difference, please re-measure the calculation.。

二、Paper setting mode

Use: Customize the position where the material is laid down after cutting, so that the materials can be stacked neatly。

Click "Setting Mode" to enter the "Parameter 2" setting, as shown below

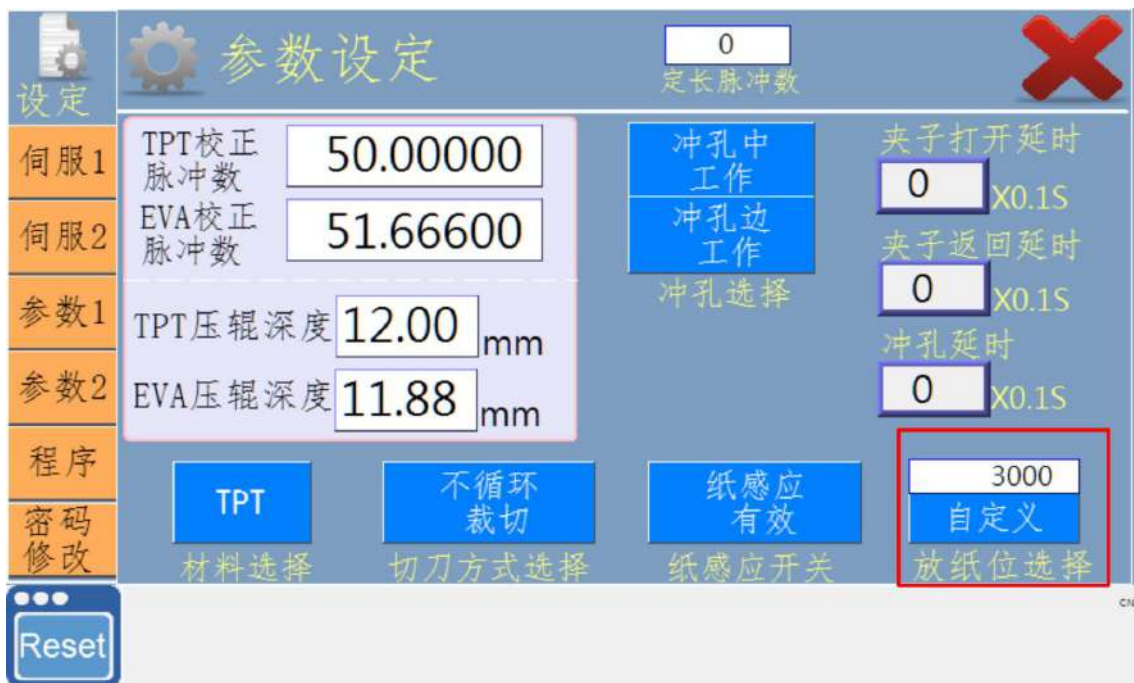

Paper position selection function: Default /Custom Two switching functions

1. Default

After the cutting of any length of material is completed, the clip is directly opened and the material is lowered; the position of the paper is equivalent to the cutting position, that is, the paper feeding position is determined by the cutting length set by the material;

2. Custom

After the material of any length is cut, you can customize the position of the material to be laid down; this function can only set the paper position backwards based on the current cutting length, and cannot be set forward.

Parameter setting method:

EVA mode: The paper position in the EVA operation mode is recommended to be set to "default". Set as above; if it is not the same cutting position will affect the stacking effect; that is, the EVA will directly drop the clip after the EVA cutting is completed, and the EVA will drop directly.

TPT mode: Due to the particularity of TPT materials, We recommend using the Custom setting. If the "default" function is used, there may be cases where the TPT cannot be dropped from the clip or dropped on the table and then slipped after the clip is opened; use the "custom" function to avoid the above situation.。

The "Custom" function settings are as follows:

1. Enter "Setting Mode" and click "Parameter 2" to switch the paper

position selection to  status;

2. Click the white box above the "Custom" to set the number of pulses that the servo motor 2 retreats; 5000 is 5000 pulses, and the actual back distance is about 10cm; the value of this parameter cannot be excessive, and the excessive setting may cause the servo motor 2 Limit alarm.

3. If the set value of the back pulse number is “0”, the clip will not be retracted after the cropping is completed, which is equivalent to the “default” function.

4. The recommended pulse value is 2000–6000.

三、Other function buttons

Go to the “Parameter 2” setting under “Setting Mode”

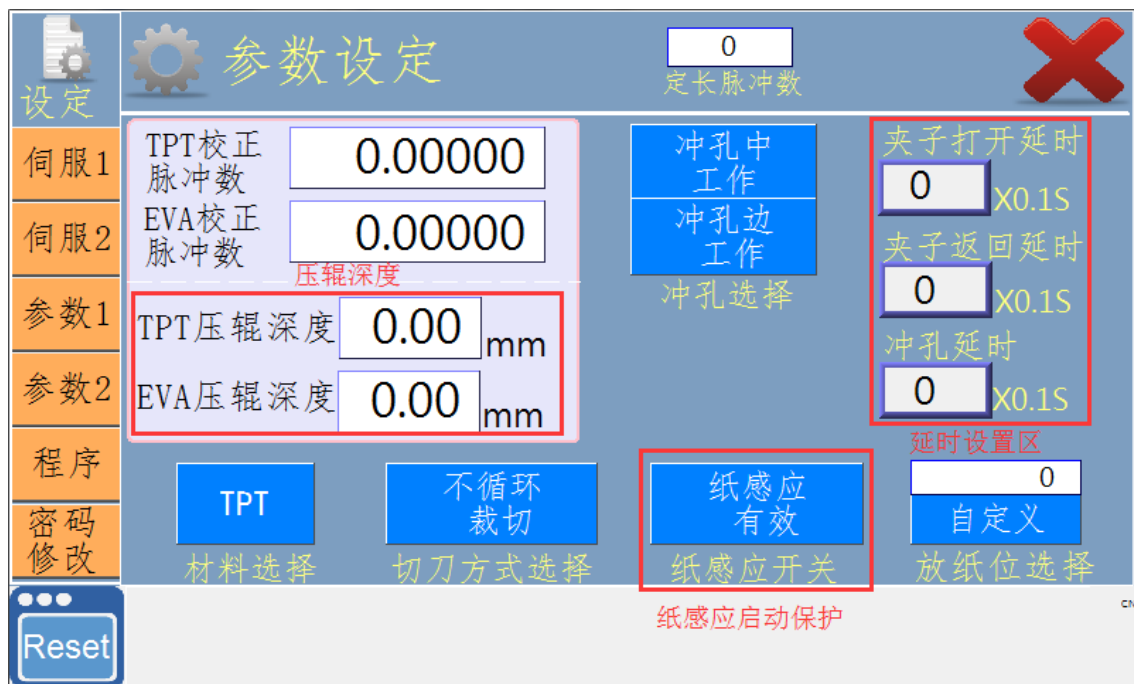

1. Roller depth

This parameter is used to adjust the depth of the pressure roller under pressure. The pressure between the pressure roller and the material can be adjusted. The smaller the value, the smaller the pressure stroke and the lower the pressure. Please adjust the parameters to a small amount. **⚠️ Do not accept training personnel, please do not modify!**

2. Delay setting

Adjust the waiting time of each link in the automatic operation to optimize the stability of the machine.

3. Paper sensor switch

The paper induction is effective, that is, the automatic operation will stop when the paper sensor at the clip does not detect the material (paper).

Paper induction is invalid, that is, the machine can be fully automated without material, suitable for debugging.

The above operation is based on the premise that the installation and commissioning of this equipment is completed!

3-2 Operational precautions

1. The switch machine must be operated by a full-time technician or by professionally trained personnel.
2. Before starting the machine, check whether the power supply has electricity, whether there are tools, rags and other debris on the working surface to ensure that the safety door is closed and the signal is normal.
3. When the machine is running automatically, it is strictly forbidden to touch the movable part to avoid personal injury.
4. Confirm the cylinder position before starting to ensure the cylinder is in place.
5. Pay attention to the installation position of each photoelectric sensor. If it is displaced, it may cause malfunction.
6. It is forbidden to place any objects on the equipment, otherwise it will damage the equipment or cause other accidents.

Chapter Four、 Abnormal situation and treatment



注意 Caution

Professionals must be inspected to prevent accidents.

Item	Alarm information	Possible Reason	Solution
1	E1: emergency stop	1、 Emergency stop button is pressed 2、 Emergency stop button to PLC input point disconnection	1、 Pull out button 2、 Check the connection of the PLC to the emergency stop button. The input point of the PLC is 0.06.
2	E2 : Press roller down pressure left error	Sensor failure or solenoid valve malfunction	1、 Check if the pressure roller solenoid valve is closed; 2、 The pressure roller solenoid valve does not work, but the pressure roller is pressed down and the left sensor is not sensed.
3	E3: Roller lifts left sensor error	Sensor failure or solenoid valve malfunction	1、 Check if the pressure roller solenoid valve is working; 2、 The pressure roller solenoid valve has been operated, but the pressure roller is raised and the left sensor is not sensed.

4	E4 : Paper clip closed sensing error	Sensor failure or solenoid valve malfunction	1、Check if the paper jam solenoid valve is working; 2、The paper jam solenoid valve is already working, but the paper jam sensor is not sensed.
Item	Alarm information	Possible Reason	Solution
5	E5: Paper clip open sensing error	Sensor failure or solenoid valve malfunction	1、Check if the paper jam solenoid valve is closed; 2、The paper jam solenoid valve has been closed, but the paper jam sensor is still sensing.
6	E6: Cutter left sensing error	1、The left cutter solenoid valve has been activated, but the cutter has not been sensed within 5 seconds.	1、Check for air pressure or if the cutter is stuck
7	E7: Cutter right induction error	1、The right cutter solenoid valve has been activated, but the cutter has not been sensed within 5 seconds.	1、Check if there is air pressure or if the cutter is stuck
8	E8: Cutter stuck	1、The induction on both sides of the cutter cannot be sensed	1、Check if the cutter is stuck 2、Whether the cutter sensor works normally, the cutter induction signal is 0.10, 0.11.
9	E9: Inductive error under punching	Sensor failure or solenoid valve malfunction	1、Check if the solenoid valve under the punching is working; 2、The punching solenoid valve is already working, but the punching sensor is not sensing.
10	E10: Punching raises the sensory error	Sensor failure or solenoid valve malfunction	1、Check if the solenoid valve under the punch is closed; 2、The punching solenoid valve is closed, but the punching sensor is still sensing.
11	E11: Paper induction fault alarm	Sensor failure or solenoid valve malfunction	1、Check if there is paper jam in the feeding area; 2、Check if the paper sensor on the binder is sensed or the sensor senses but no output.

12	E13: Cutter sensor failure	Sensor failure or solenoid valve malfunction	Check if the cutter sensor has an output signal.
13	E15: The cutter can work after the platen is pressed down	no	Operate in the correct way
Item	Alarm information	Possible Reason	Solution
14	E16: The motor can work after the punching is lifted.	no	Operate in the correct way
15	E17: Press roller press right error	Sensor failure or solenoid valve malfunction	1、 Check if the pressure roller solenoid valve is closed; 2、 The pressure roller solenoid valve does not work, but the pressure roller is pressed down and the right sensor is not sensed.
16	E18: Roller lifts right sensor error	Sensor failure or solenoid valve malfunction	1、 Check if the pressure roller solenoid valve is working; 2、 The pressure roller solenoid valve has been working, but the pressure roller is raised and the right sensor is not sensed.
17	E19: Pressure plate pressing left sensing error	Sensor failure or solenoid valve malfunction	1、 Check if the pressure plate solenoid valve is working; 2、 The pressure plate solenoid valve has been operated, but the pressure plate is pressed down and the left sensor is not sensed.
18	E20: Pressing the plate to press the right sensor error	Sensor failure or solenoid valve malfunction	1、 Check if the pressure plate solenoid valve is working; 2、 The pressure plate solenoid valve has been working, but the pressure plate is pressed down and the right sensor is not sensed.
19	E51: Servo motor 1 alarm	1、 Servo drive alarm, servo driver LED has alarm information output; 2、 Servo drive to PLC disconnected	Check the alarm code on the drive and solve the problem according to the drive manual
20	E52: Servo motor 2 alarm	1、 Servo drive alarm, servo driver LED has alarm	Check the alarm code on the drive and solve the problem according

		information output; 2、 Servo drive to PLC disconnected	to the drive manual
21	E91 : Servo limit CCWL alarm	1、 Check if the motor is over the limit; 2、 Check if the connection of the limit sensor is intact	Turn off the power to remove the sensor; replace the sensor or reconnect it

Servo drive parameter setting

 After replacing the servo drive or setting the initialization, you need to reset the servo drive parameters.

Item	Parameter number	name	Settings
1	PA201	Position control function switch 2	d.0002
2	PA205	First electronic gear ratio	10
3	PA510	Output signal form selection	3140
4	PA200	Position control function switch 1	d.0001

Inverter parameter setting

 When replacing the inverter or setting up initialization, please contact the manufacturer.

Angle sensor parameter setting

 When replacing the angle sensor or data loss, please contact the manufacturer.

Chapter Five、 Protection and inspection

5-1 Regular maintenance inspection

In order to ensure normal production, it is necessary to standardize the daily maintenance and repair work of the equipment, reduce the loss of the fault, and improve the work efficiency. It is necessary to formulate the “Daily Maintenance Work Record Book” .



注意 Caution

- After an abnormal situation occurs, the abnormal condition must be excluded before it can be turned on again. .
- Non-designated workers are not allowed to perform maintenance and replacement parts. (Remove metal objects such as watches and rings before work, and use tools with insulation when working)
- Never modify the unit yourself.
- The running performance and surrounding environment conform to the standard specifications. No abnormal noise, vibration and odor.
- The indicator light shows normal, no overheating or discoloration. Prevent electric shock and equipment failure.
- The main power switch should be turned off when performing maintenance work.
- There must be a clear indication at the relevant location that maintenance work is being performed.
- If you have any questions about the maintenance of Luoyuan Photovoltaic Equipment Co., Ltd., please contact Luoyuan Photovoltaic Equipment Co., Ltd. Service Department

Examples of daily inspection and maintenance are as follows:

1. Check the power supply first before use, pay attention to voltage changes.
2. Check if the PLC enters the operation interface, and the “GO” in the lower right corner displays.
3. Please remember the factory password “LY5588” before operation.
4. Check if the air pressure is normal.
5. Check if each spool system is working properly.
6. The gap between the loading mechanism and the transfer system is normal.
7. Check whether the parameter of the set length and the program number actually match.
8. At the same time, check whether the relevant solenoid valve is working properly during operation.

9. Add lubrication to the lubrication system once a week.
10. Use a high-pressure air gun to blow off equipment surface residues every day after work.
11. Perform maintenance work on switches, display screens, control boxes, etc. of electrical equipment.
12. The purpose of routine maintenance is to make the whole equipment control system normal, no accidents.

WARNING: Always turn off the power to the equipment before servicing or servicing the equipment. ! ! ! surroundings

Check item	Inspection Method	Check cycle		
		daily	per month	One year
Confirm ambient temperature, humidity, vibration and presence of dust, gas, oil mist, water droplets, etc.	Measure with visual or instrument	★		
There are no foreign objects and dangerous goods placed around the tool.		★		

Voltage

Check item	Inspection Method	Check cycle		
		daily	per month	One year
Is the main circuit and control circuit voltage normal?	Measuring with a universal meter	★		

Machine component

Check item	Inspection Method	Check cycle		
		daily	per month	One year
No abnormal sound, abnormal vibration?	According to visual and auditory		★	
Are the bolts (fasteners) not loose?	Lock		★	
The spring force of the clamping device is within the appropriate	Measuring force		★	

range?				
Wear of the transport device and sliding track?	Based on visual and auditory		★	
Ball slides, cylinders (special lubricants) need lubrication?	Based on visual and auditory		★	
Is the cylinder position normal?	Visual inspection	★		
Is it not contaminated with waste, dust or dirt?	Visual inspection		★	

Electrical System

Check item	Inspection Method	Check cycle		
		daily	per month	Half a year
Every proximity switch works fine?	Measured by visual and tool	★		
Are all emergency stop functions normal?	Test emergency stop function		★	
The machine and insulator are free from deformation, cracks, breakage or discoloration due to overheating and aging?	Visual inspection			★
Is the circuit terminal not damaged?	Visual inspection			★
Is it not contaminated with waste, dust or dirt?	Visual inspection			★
No leaks, discoloration, cracks and shell expansion?	Visual inspection			★
Is the connection damaged? Is the contact contact good?	Measuring resistance with a multimeter			★

⚠ Special Note: *This product has more cylinders and linear motion mechanisms. Avoid running debris and lumps that may fall into the motion gap around the product!*

Chapter Six、 After sales service

6-1 Installation, on-site training

1、 We provide equipment service system, including equipment installation, equipment commissioning, and personnel training.

2、 During the installation and operation of the equipment, we arrange technicians to carry out on-site commissioning and operation training. We need to provide 1-3 operators and a maintenance worker to assist in debugging and training.

3、 During the stable operation of the equipment, we will also track the customer's usage and track and guide the equipment's use, maintenance, maintenance and operation methods.

6-2 After sales service

1、 The equipment provided by us strictly implements relevant standards and technical requirements. For example, if there is a problem in the equipment itself during the warranty period (except for damage caused by human damage or improper human operation), we will repair the equipment for free; the product and equipment are guaranteed for life.

2、 After the equipment is commissioned and operated, the customer will continue to track and give technical services. After the equipment fails, after receiving the customer's feedback, organize the technical personnel to analyze the problem in time, give a phone answer within 1 hour and solve the problem. If the technician needs to solve the problem on site, our technical staff will Arrive at the scene within 24 hours of receiving feedback and resolve the problem as quickly as possible.

3、 We establish equipment files for the equipment purchased by our customers, track the operation of the equipment for a long time, and provide technical guidance on a regular visit.

4、 We have sufficient inventory of the accessories used on the equipment and long-term supply, which solves the worries of customers when they need to replace spare parts.

5、 We have a professional after-sales service organization and a professional after-sales service team, with service repair calls, so that when customers have maintenance and repair needs, we will respond to customer requests as soon as possible.

Service warranty call:0513-83695388

Company email: luoyuanpv@163.com

Company website: www.luoyuanpv.com

**Company Address: No. 8, Huihe West Road, Huifeng Town,
Qidong City, Jiangsu Province, China**